

# Infosec & contra-surveillance

Bij falende politiek gebruiken we technologie om privacy & vrijheid van meningsuiting te garanderen

Arjen Kamphuis  
a.kamphuis@brunel.net



# My First Cavity Search



Helping your child understand why he may pose a threat to National Security



Ages 6  
and up



Homeland  
Security

# THE MIDDLE EAST



SECY GATES MEETING WITH ISRAEL'S  
MINISTER OF DEFENSE EHUD BARAK

**LIVE**DESK

WHAT THE GOVT DID NOT COERCE CHRYSL DOW ▼ 37.94



*"I'm right there in the room, and no one even acknowledges me."*



**Mein Vater sagt,  
Sie können in  
meinen Computer  
gucken**

**Das ist nicht  
dein Vater**



## For the NSA, espionage was a means to strengthen the US position in climate negotiations

At the Copenhagen Climate Summit in 2009, the world's nations were supposed to reach an agreement that would protect future generations against catastrophic climate change. But not everyone was playing by the rules. A leaked document now reveals that the US employed the NSA, its signals intelligence agency, to intercept information about other countries' views on the climate negotiations before and during the summit. According to observers, the spying may have contributed to the Americans getting their way in the negotiations

ontgomery



03.06.2015 10:19

«Previous | Next »

## Ex-BND-General: NSA wanted to pursue economic espionage

vorlesen / MP3-Download



(Photo: German Bundestag / Simone M. Neumann / NSA)

**A former BND department chief has confirmed that the NSA wanted to scour the abgefischten in the operation eikonal data for keywords like "EADS" or "Eurocopter". Killer drones could be fed by "lucky strike".**

Dieter Urmann, formerly Head of Technical education at the Federal Intelligence Service (BND) has, for the first time publicly admitted that the NSA a Frankfurt hub of Deutsche Telekom not only because of spying to combat terrorism and weapons proliferation. The retired Brigadier General confirmed on Thursday in NSA investigative committee of the Bundestag a [report](#), after which it the US intelligence cooperation project in the [eikonal](#) was after about on "EADS", "Eurocopter" and "French authorities".

This was noticed from a list of "selectors", which tried to foist the BND the foreign partner, led the 63-year-old during his [questioning of witnesses](#) from. Generally I'm a project of this size, "every day something else, not just one of those things". In principle, however, was determined from the outset that "not German citizens or

Display

### Top News

Energy Transition: New power lines may be on existing routes

Intel Xeon processor-D-1500: Anti-ARM server

Mail Encryption: Cautious response to PGP for De-Mail users

Censorship jack rights: WordPress and Blogger win in court against DMCA abuse

Telekom is also to telephone lines without DSL to IP technology

### Top-Newsletter

The main messages 2 x week.



Sign In

[Privacy Policy](#)



### c't Shariff for more privacy

Just a click requires further development of our two-click solution for safe parts per button social network.

### Telepolis Send Kosmogramm or not?

Dispute at this year held in San José Triple-A Conference



# WikiLeaks Publishes NSA Documents Detailing Economic Espionage by 'Five Eyes' Alliance Against France

KEVIN GOSZTOLA JUNE 29, 2015 AT 12:00 PM PDT 1 COMMENT



Graphic created by WikiLeaks for release of documents showing French economic espionage

WikiLeaks published documents from the National Security Agency showing details of economic espionage against France by the "Five Eyes" alliance, which consists of the United States, Great Britain, Canada, Australia and New Zealand.

One document is an "information need" [spying order](#) that was first created in 2002. It shows that the alliance sought information on economic relations with the United States, French business practices, relations with least developed countries and transitional states, foreign contracts, French trade, French views, views on G8/G20 developments/issues, budgetary constraints/contributions to NATO, and "questionable

Search

Google™ Daten Such

Follow Us

Popular

Recent Posts

[SCOTUS rules against Oklahoma inmates challenging execution with midazolam](#)

[WikiLeaks Publishes NSA Documents](#)



ISN'T IT GREAT?  
WE HAVE TO  
PAY NOTHING  
FOR THE BARN

YEAH!  
AND EVEN  
THE FOOD  
IS FREE

# FACEBOOK AND YOU

If you're not paying for it, you're not the customer. You're the product being sold.



# QUANTUMINSERT

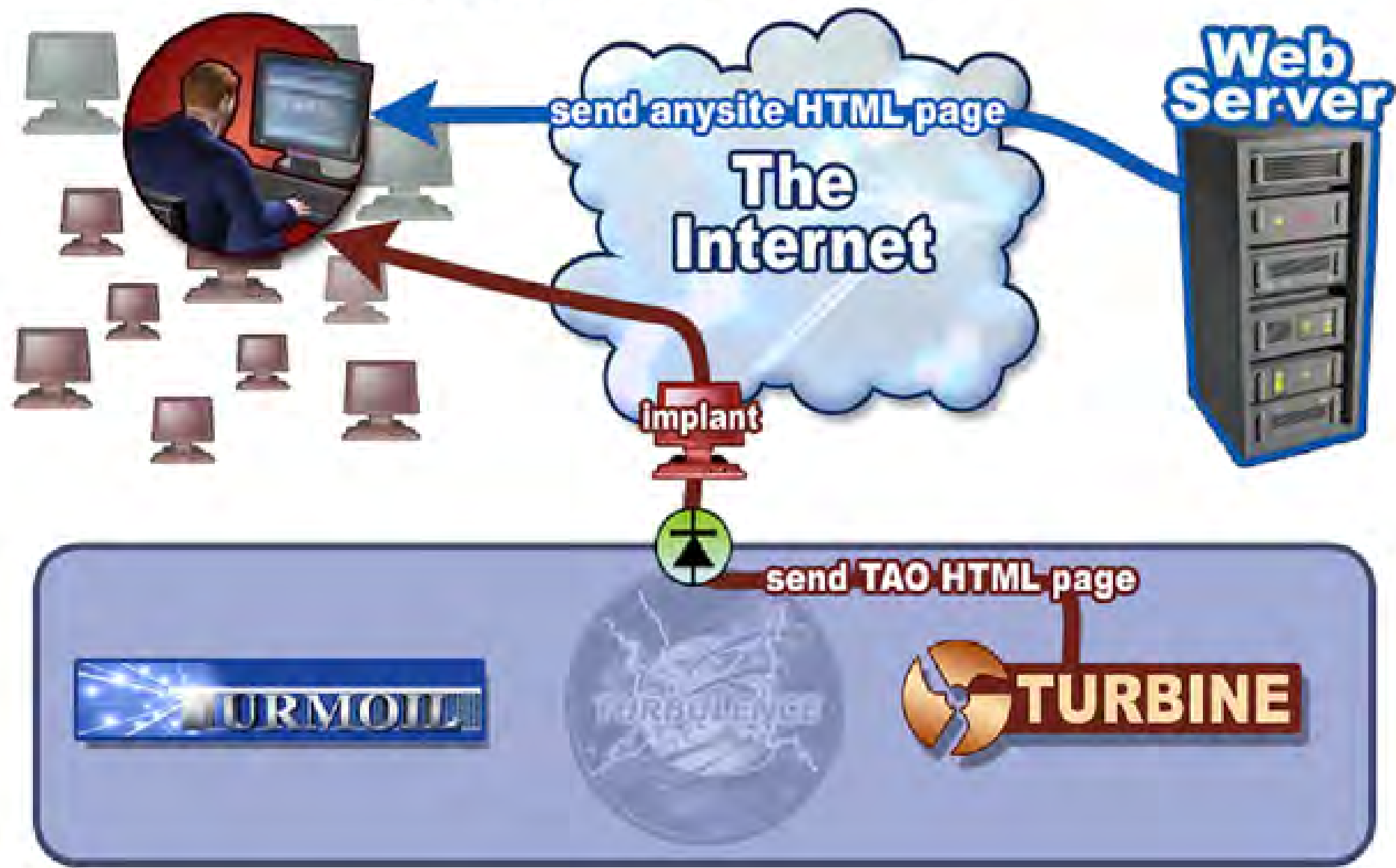



POLICY > GOVERNMENT

# NSA slides reveal: iPhone users are all ZOMBIES

**OK, not literally. Plus: Our favourite spooks show us how to hack an iPhone – report**

By Bill Ray, 9th September 2013



34

Spooks at the US National Security Agency (NSA) can't believe we're all paying for the equipment it's using to spy on us, describing Steve Jobs as Big Brother and iPhone buyers as "zombies".

## RELATED STORIES

US intelligence: Snowden's latest leaks 'road map' for adversaries

**Analysis** That earth-shattering

That assertion comes from NSA documents leaked to [Germany's Spiegel Online](#).

The self-promoting presentation, purportedly an internal NSA report from 2010 titled "Exploring Current Trends, Targets and Techniques", includes a number of slides presenting snapshots of grinning iPhone-brandishing customers as analogous to the "zombies" brainwashed by Big Brother – in a reference to George Orwell's *Nineteen Eighty-Four*.

Mobile

# Malware Is Still Spying On You Even When Your Mobile Is Off

- Android
- Hynek Blinka
- malware
- Mobile



FEBRUARY 18, 2015

Newly discovered Android malware hijacks your phone when you believe you have switched it off.



AVG  
Blogs

[More articles](#)

[Other authors](#)

Series: [Glenn Greenwald on security and liberty](#)

---

# Revealed: how Microsoft handed the NSA access to encrypted messages

- Secret files show scale of Silicon Valley co-operation on [Prism](#)
- Outlook.com encryption unlocked even before official launch
- Skype worked to enable Prism collection of video calls
- Company says it is legally compelled to comply

---

**Glenn Greenwald, Ewen MacAskill, Laura Poitras, Spencer Ackerman and Dominic Rushe**

The Guardian, Thursday 11 July 2013 18.53 BST

 [Jump to comments \(1971\)](#)

---



# NSA Strategic Partnerships



## Alliances with over 80 Major Global Corporations Supporting both Missions

- Telecommunications & Network Service Providers
- Network Infrastructure
- Hardware Platforms  
Desktops/Servers
- Operating Systems
- Applications Software
- Security Hardware & Software
- System Integrators





# TIN FOIL

FREE YOUR MIND



A yellow diamond-shaped sign with a black border, mounted on a black post. The sign features the text "Now what?" in a bold, black, sans-serif font. The background is a clear blue sky with some light, wispy clouds.

**Now  
what?**



**KEEP  
CALM  
AND  
FIGHT  
BACK**

NOW AND THEN, I ANNOUNCE "I KNOW YOU'RE LISTENING" TO EMPTY ROOMS.

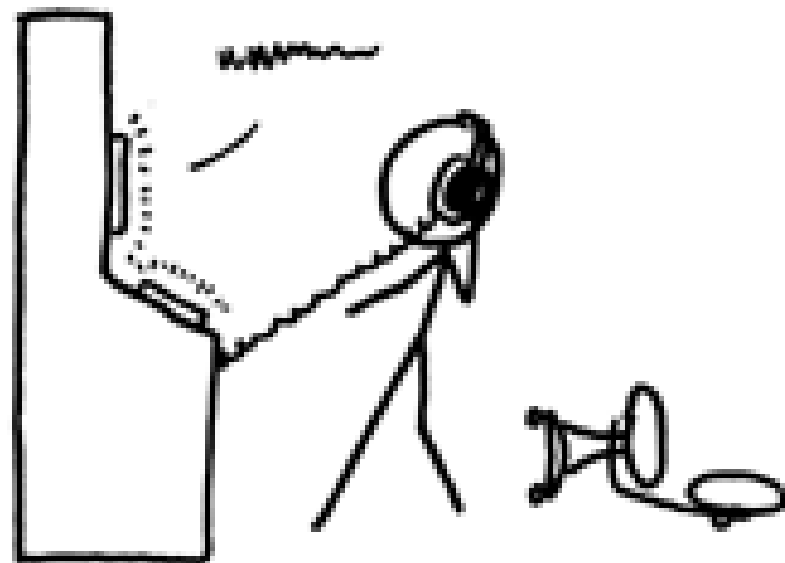

IF I'M WRONG, NO ONE KNOWS.  
AND IF I'M RIGHT, MAYBE I JUST FREAKED  
THE HELL OUT OF SOME SECRET ORGANIZATION.



NSA budget: \$100+ billion

(ongeveer \$0,10 per internet(s)ter per dag)



Verhoog de kosten van surveillance op jou van \$0,10 per dag naar \$100.000+ per dag



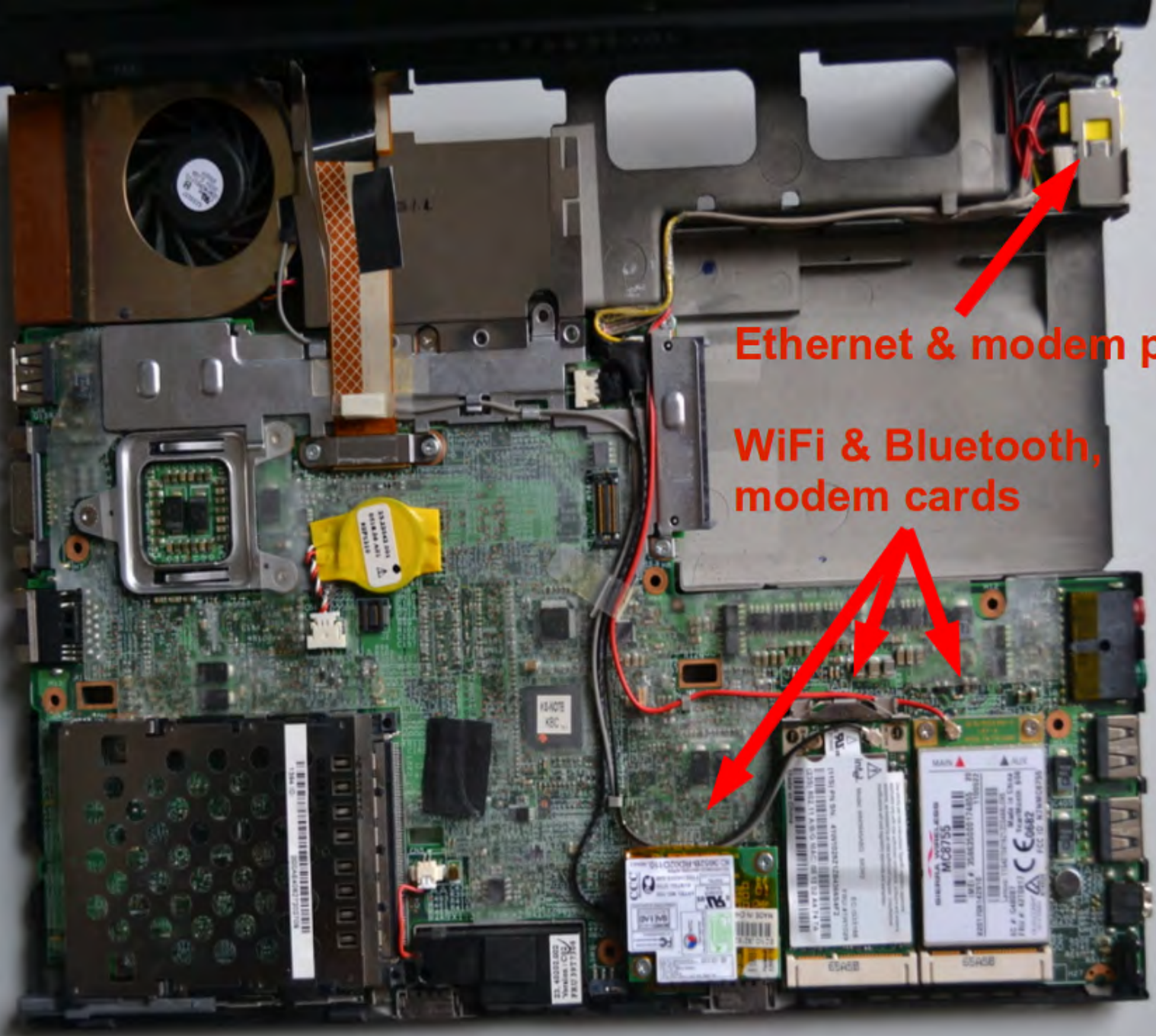

**Ethernet & modem ports**

**WiFi & Bluetooth,  
modem cards**

# How Tor Works: 2



Step 2: Alice's Tor client picks a random path to destination server. **Green links** are encrypted, **red links** are in the clear.

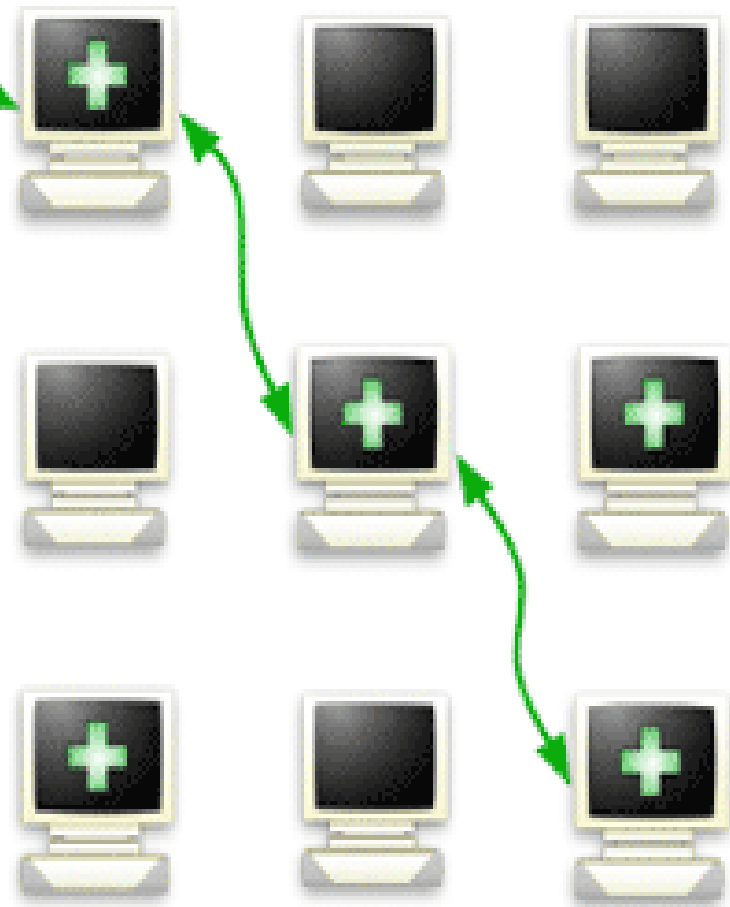



**I changed all my passwords to "incorrect".**

A meme featuring Steve Moss from the TV show 'The Office'. He is wearing his signature brown suit, blue shirt, and red tie, and is holding a banana. He has a wide, toothy smile and is wearing his glasses. The background is a blurred office setting.

**So whenever I forget, it will  
tell me "Your password is incorrect."**

# WHICH CHARACTERS ARE REQUIRED IN MY **PASSWORD**?

*HINT: it depends on password length!*

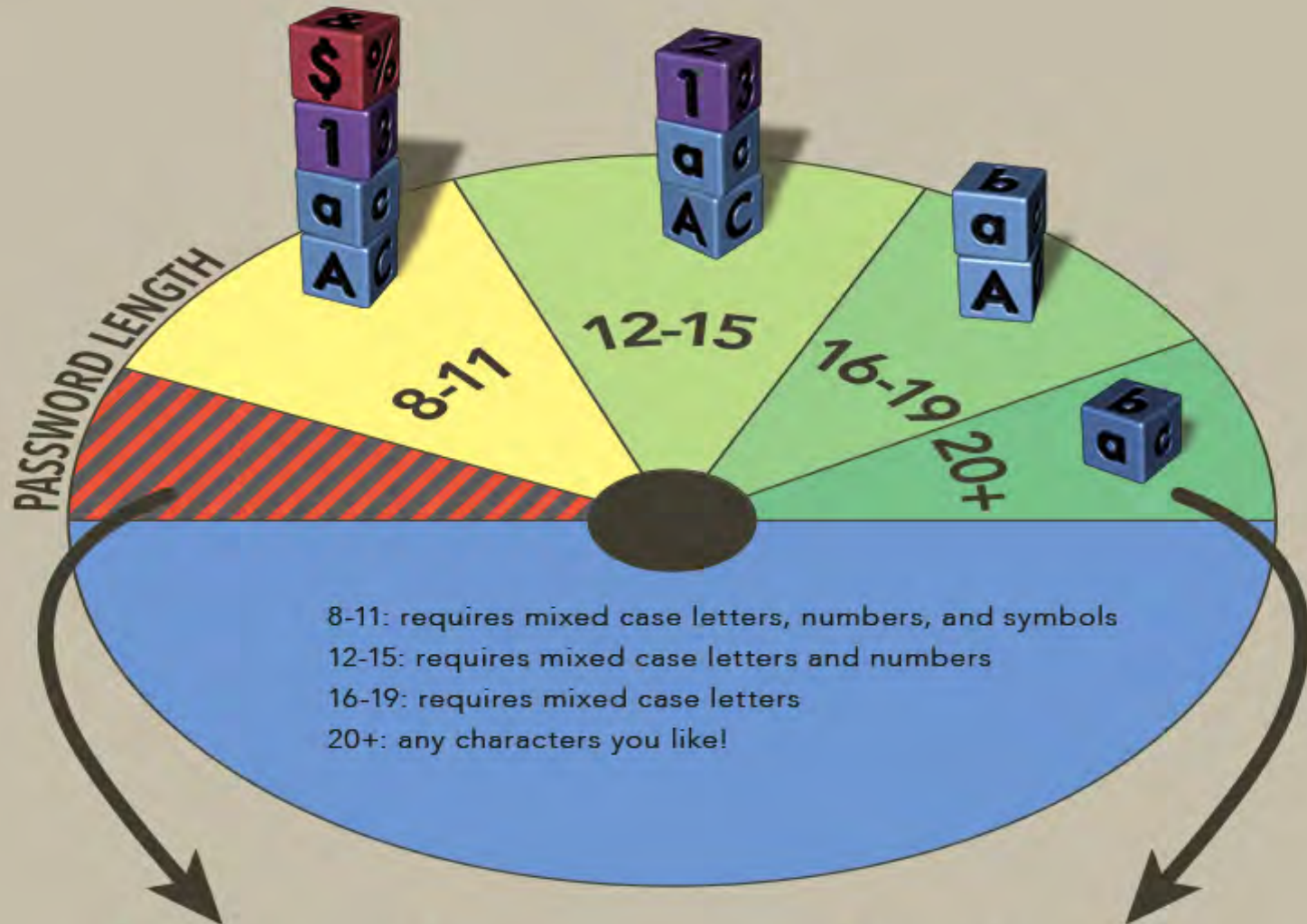

# Bob

Hello  
Alice!

Encrypt



Alice's  
public key

6EB69570  
08E03CE4

---

# Alice

Hello  
Alice!

Decrypt



Alice's  
private key

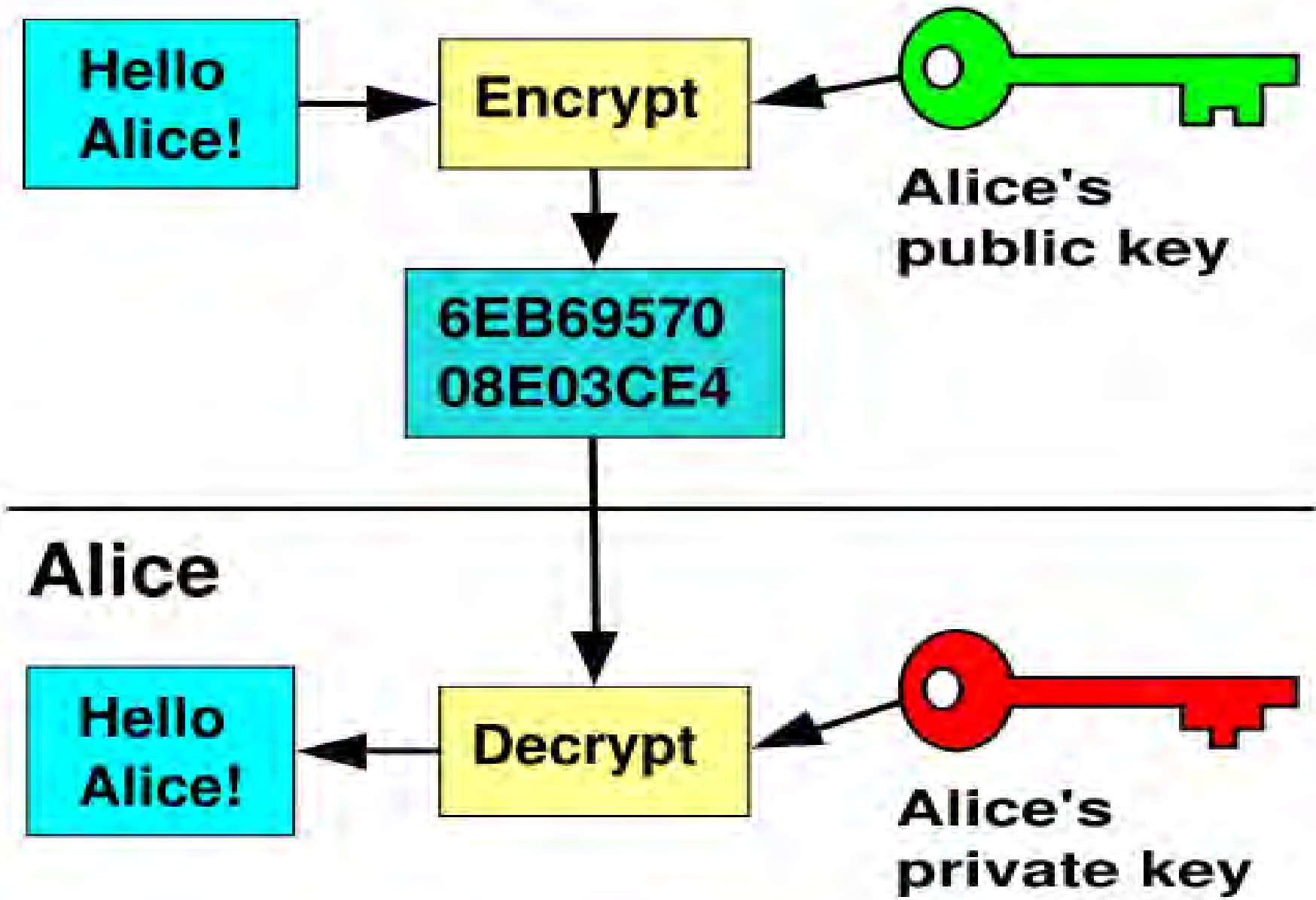

From: Arjen Kamphuis <arjen@gendo.ch> arjen@gendo.ch

To: [Redacted] >

Subject: work

-----BEGIN PGP MESSAGE-----

Charset: utf-8

Version: GnuPG v1

hQEMA5Qr4Gnc44GsAQgAlPQb8z30n7l6+RJGWVXXTcWVG6GnpxeH1hS9Cr/j/1R7  
vzC87Qy0NQF95J/A9/GqFYIRR1w3236W1gA+iQPkiJmWkybM9rV+o2YQDqxFJ0z1  
fRS/+0nh5IyaVcgYzDrqzSYJiPp4RI8ivuodHbFtbcbzs1XuFX7Hf17pnP6LEIF8  
1RC0vJ3fgZGyLgCVqBpuzomH3aZrFhQBxET9obUaoHp628QaFhcRWYH8WA7K0AmG  
qwabKQeWEc/9a5P/yt0fKPyesZzgoaGtM0XIIS8VUJTSldbnfhZtxY0wsloD4bts  
jQnKHb01i0rjEbWtGv+sGYhISXHSfLCYWUQhyTIDc4UCDA0zLG8HzX6gVgEQAJOm  
N/kZ/JwJkGB6+EQU1H3rhQ7nYQsgwJ2QLfsVC5L0ixypaIIm/nb9T/Y8Mi+9QCiz  
zFNKEkT2JubKBS2Tjof6rmX1wk3xNZpqJsBc4QEd+ntRUH7w1JSdwhehYynCdNAN  
Kft1UM3nprGKfvp1TCb8c4nSY5b405QtKgBHXqelg6pnUltM0f27+sxUeaPize/o  
tjisnoBozcYsVHbP

TcWpvIi5rHfVvNev  
0ZKPLWoXmTImEbVe  
UD84M1Rg5sN8HHm  
TxMY0whgjiJkHwzy  
ibvFODmvGGnXfQq  
jYajQQb0oP/kGdg  
nAWUDIwk7NnsTPUpynU/1YjEaPeJ08YAVdtbetKj0u0B/XaLH/HM25XKPnd0S0WJ  
enQUE7TtKLWtyo0xT7UsP3jJ8memIkdHS+IFoA0AVzI0rBhiY6BW0T9qD0KTun+eV

 Send SIGNED ENCRYPTED message to [Redacted]

Note: the message is encrypted with the following  
User ID's / Keys: [Redacted]

Cancel Send Message







- Courses
- Events
- #CIJSummer
- FilmFestival
- Resources

## Resources

- Audio and Video
- Books
- The Logan Handbook Series

### Information Security for Journalists

- Contents
- Acknowledgements
- Preface: Silkie
- Preface: Arjen
- Introduction
- Chapter 1: Protecting the System
- Chapter 2: Operating System
- Chapter 3: Safe Browsing
- Chapter 4: Data
- Chapter 5: Email
- Chapter 6: Instant Messaging
- Chapter 7: Phones & Voice/Video Calls Over Internet
- Chapter 8: Passwords
- Glossary
- About the Authors

### Investigative Photography

### DPA without the Lawyer

### EIRs without the Lawyer

### FOIA without the Lawyer

### The Story Tells the Facts

### The Hidden Scenario

Home > Resources > The Logan Handbook Series

## Information Security for Journalists

By Silkie Carlo and Arjen Kamphuis

Download the book in [PDF](#), [ePub](#), [MOBI](#), or [view it online](#). For SHA-256 hashes for verifying the table below.

This handbook is a very important practical tool for the importance to investigative reporters. For the first virtually every electronic communication we make and subject to analysis and action. As this surveillance without scrutiny, transparency or any realistic form stories and our professional work itself is under the

Journalists were dismayed by the realisation that their work is now being recorded; for them and their sources their work. This danger does not just worry reporters information and whose privacy is considered fundamental. Lawyers and accountants and their clients are now secret surveillance of an increasingly authoritarian

After knowing how Snowden's disclosures were so counter measures available. The CIJ's latest handbook means of keeping your work private and safe from how to safely receive, store and send information know, to have or to share. To ensure your privacy help you to make your communications indecipherable

When planning work that must remain private and be associated with it. Shop floor maintenance, but be areas where the precautions and methods designed your work. In these cases a phone call made or received



# Information Security for Journalists

## Protecting your story, your source and yourself online

By Silkie Carlo and Arjen Kamphuis

hQEMAxQ6GHdT/9WoAQf+PnS6MEmCisHF1QMrbD+tTPq44j4DI Ojl2erU1ZfaSnGBn526g5jwPq2rFdku2bR1dePIYdgrZyXAn++kVQwb2X9qaK8o4YTSWenE0fhBgWrvXmauXoKC9apkjt8gtNfCZC2V3NzPzp/PyDK+9tUGXitp6lfjee1G1GbIUhIHsBxwFOqLYrkvwR5HVSi7cCYicSh4C6yUfyuoLfwT/YkzQl2pZ3AScVBoGuJX1sN6xUf6JC62sIF01LHNeLRomuA1dDj8fn2ApCdocuxDK7cl81SUycjEWBKKZwv4CIv0QMh



Arjen Kamphuis  
a.kamphuis@brunel.net

03BC C848 7B4F 439D B137  
4CC5 3A96 2BAF 7846 EC26